

X-SERIES **USER'S MANUAL**

Operating & Maintenance
Instructions



Published by **SJE Corporation, Ltd.**
Copyright © 2017 by SJE Corporation, Ltd.

78-21, Sandan 7-Ro, Jeongwan-Myeon, Gijang-gun,
Busan, Republic of Korea

Tel: +82 51-521-3200

Fax: +82 51-521-3305

Website: <http://www.sjecorp.com>

E-mail: sales@sjecorp.com

*All rights reserved. No part of this publication may be reproduced, stored
in a retrieval system, or transmitted, in any form or by any means, electronic, mechanical,
photocopying, recording, or otherwise, without the prior permission of SJE Corporation, Ltd.*

Printed in Republic of Korea
SJE20170101

Manufactured by
SJE Corporation, Ltd.



User's Manual

Model: OPTIMA X-SERIES

Ver. G2.3.00

Distributor's Contact Information:

Table of Contents

<i>Introduction</i> -----	2
<i>Applications</i> -----	2
<i>Product Specifications</i> -----	2
<i>Exterior Descriptions OPTIMA XD</i> -----	4
<i>Exterior Descriptions OPTIMA XE</i> -----	5
<i>Safety Precautions</i> -----	6
<i>Included Items and Accessories</i> -----	9
<i>Pre-Start Procedure</i> -----	10
<i>Standard Operating Procedure</i> -----	12
<i>ADJUSTING AIR FLOW (For OPTIMA XD)</i> -----	15
<i>Moisture Control</i> -----	15
<i>EMERGENCY STOP</i> -----	16
<i>PAUSE OPERATION</i> -----	16
<i>SHUTDOWN OPERATION</i> -----	16
<i>Maintenance</i> -----	17
<i>Freeze Prevention</i> -----	21
<i>Troubleshooting Guide</i> -----	23
<i>OPTIONAL ITEMS</i> -----	31

Introduction

The Optima Steamer continues to pursue environmentally friendly and effective cleaning solutions. Optima Steamer which is safe, durable and easy to use will support your cleaning operations for many years to come.

Applications

The Optima Steamer is capable of generating continuous, super-heated vapor steam. The Optima Steamer is specifically used for various cleaning applications including cleaning machinery & components, washing vehicle exteriors, interiors, engine compartment, glass, metal surfaces, windows, wheel wells, vents, deodorizing bad odors, sanitizing hazardous food-borne bacteria from food processing equipment, removing weeds and more.

Product Specifications

(1) OPTIMA XD

Model	OPTIMA XD
Working Pressure	7~8.5 kg/cm ² (99~121 psi) max. 9.5 kg/cm ² (135 psi)
Steam Temperature	178°C max. 180°C (352.4 °F max. 356 °F)
Preheating Time	3 ~ 4 min.
Rated Electricity Power	0.3 Kw (max.)
Voltage / Hertz	220V / 60Hz
Water Consumption*	Max. 300 ~ 1200cc/min. (0.08~0.32gpm)
Water Tank Capacity	34 ℓ (8.9 gals)
Fuel Tank Capacity	37 ℓ (9.7 gals)
Fuel Nozzle	1.10 gallon/hour @ 10.0 bar
Net Weight	91 kgs (200 lbs)
Dimensions [L] x [W] x [H]	995 x 660 x 887 mm (39 x 26 x 35 inch)

* Water consumption can be different depending on the use of the Moisture Control Valve. (See page 15, "Moisture Control")



✳ For user's safety, DO NOT modify factory settings for steam pressure and temperature.

(2) OPTIMA XE

Model	Optima XE (05K, 12K, 18K, 27K)			
	05K	12K	18K	27K
Working Pressure	7~8.5 kg/cm ² (99~121 psi) Max 9.5 kg/cm ² (135 psi)			
Steam Temperature	178 °C Max. 180 °C (352.4 °F Max 356 °F)			
Preheating Time	20~21 min.	8~9 min.	6~7 min.	6~7 min.
Electrical Power	5.2Kw	12.2 Kw	18.2 Kw	27.2 Kw
Voltage / Hertz	200 ~ 240V, 1Ph, 50/60Hz	208V, 230V, 380 ~ 600V 3Ph, 50/60Hz		380 ~ 600V 3Ph, 50/60Hz
Water Consumption*	Max. 300 ~ 1200 cc/min (0.08~0.32 gpm)			
Water Tank Capacity	71 ℓ (19 gal.)			
Net Weight	78 kgs (171.2 lbs)			87 kgs (191.8 lbs)
Dimensions [L] x [W] x [H]	995 x 660 x 887 mm (39 x 26 x 35 inch)			

* Water consumption can be different depending on the use of the Moisture Control Valve.
(See page 15, “Moisture Control”)



※ For user's safety, DO NOT modify factory settings for steam pressure and temperature.

Exterior Descriptions OPTIMA XD

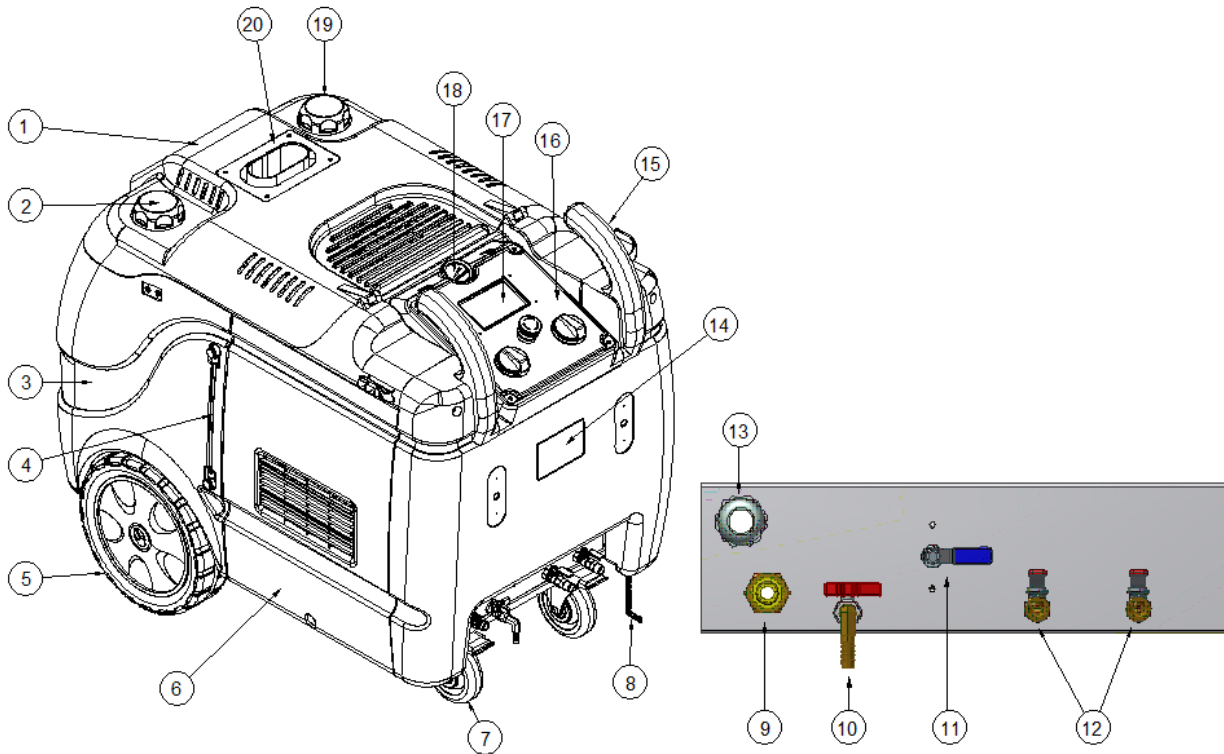

- | | |
|------------------------------|-----------------------------|
| 1. Top cover | 11. Moisture control valve |
| 2. Tank cap | 12. Steam outlet valves |
| 3. Water tank | 13. Electrical cable holder |
| 4. Water level indicator | 14. Specification sticker |
| 5. Front wheel | 15. Handles |
| 6. Lateral/Side panel | 16. Control panel box |
| 7. Rotary caster | 17. LCD Display |
| 8. Grounding chain | 18. Pressure gauge |
| 9. Quick plug for feed-water | 19. Fuel tank |
| 10. Drain valve | 20. Flue |



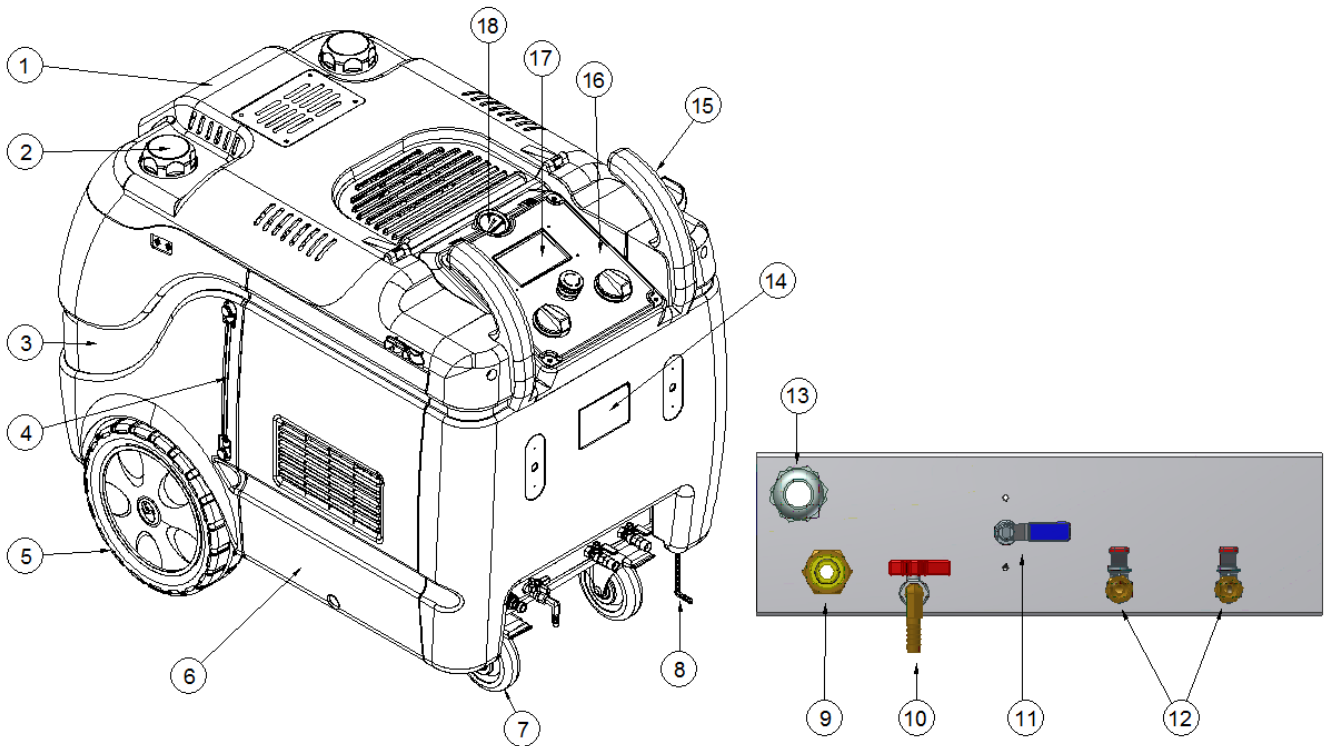





Exterior Descriptions OPTIMA XE



- | | |
|------------------------------|-----------------------------|
| 1. Top cover | 10. Drain valve |
| 2. Tank cap | 11. Moisture control valve |
| 3. Water tank | 12. Steam outlet valves |
| 4. Water level indicator | 13. Electrical cable holder |
| 5. Front wheel | 14. Specification sticker |
| 6. Lateral/Side panel | 15. Handles |
| 7. Rotary caster | 16. Control panel box |
| 8. Grounding chain | 17. LCD Display |
| 9. Quick plug for feed-water | 18. Pressure gauge |

Safety Precautions

Visual Symbols

	To ensure correct and safe usage with a full understanding of this product's performance, please be sure to read through this User's Manual completely and store it in a safe location. The contents of this User's Manual and the specifications of this product are subject to change without prior notice.		
	Caution		Warning!
	Risk of Electric shock		Risk of Burns
	Risk of Suffocation		Slippery Surface
	DO NOT operate on an incline		Wear appropriate protective gear (Goggles, ear plugs, gloves)

 The manufacturer assumes no responsibility for any consequential losses or damages including but not limited to injury of persons, loss of business or properties which may occur through use of this product without consulting the User's Manual, regardless of any failure to perform on the part of this product.

GENERAL SAFETY RULES

- DO NOT direct, air or discharge the steam jet at itself, persons, animals or live electricity.
- Use and store the product on a level ground (surface) only.
- DO NOT use the product if any part, power cord, safety device, hose or spray gun are visually damaged or suspected of being damaged.
- DO NOT use the product in rainy or snowy weather outdoors. This product is not weather-proof or water-proof.
- Never leave the product unattended while operating.
- Make sure to comply with safety rules in the event of operating in a danger area.
- Never use the product in an area where a fire and explosion hazard exists.
- DO NOT use the product below 0°C (32°F) or in extremely cold weather.
- DO NOT allow water sit in the water pipelines and steam vessel if leaving the product non-operational in cold weather.
- Store the product at a room temperature(See page 18, "Freeze Prevention")
- Heavy object. Be cautious when carrying or lifting. (See page 2, "Product Specifications")
- Unplug the product from its power source and release all the remaining steam from the product before carrying.



- Use only "Clean" and "Soft" water in the product.
 - Use of a water softener is recommended to prevent scale build-up
 - Using any kind of boiler water treatment (solution) can help decrease scale build-up.
 - DO NOT add detergent, wax or any chemical liquid in the water tank or steam vessel.
 - DO NOT use distilled water or filtered water below 15 ppm.
 - Connect to electrical power according to the product specifications. (See page 2, "Product Specifications")
 - Connect to the electrical power outlet installed in accordance with IEC 60364.
 - Be cautious of the risk of electric shock in the event of connecting to electrical power.
 - Ensure the connection status of Grounding Chain and Ground Wire to the product to avoid static shocks.
 - Users about to use the product should carry out a visual check for insecure cable at entry to a plug, evidence of poor wire connections or evidence of appliance or plug overheating.
 - Make sure that all the switches on the product are off before plug-in power cables.
 - In the event of using extension cord, make sure of a ground-fault circuit interrupter (GFCI) built in.
 - Make sure extension cord is constructed of proper diameter in accordance with the electrical specifications. (Contact manufacturer or distributors for right extension cord)
-
- Keep out of reach of children and pets.
 - This product is not intended for use by children, or by persons with reduced physical, sensory or mental capabilities, or by person lacking experience with the product or knowledge of the product's use, unless they have given supervision or instruction concerning the use of the product.
 - Wear appropriate protective gear to protect users' ear, eyes and hands in operation.
 - According to steam pressure, noise can be reached to 95 decibel(dB).
 - DO NOT use the product within the range of persons who are not wearing any protective gear.
 - Hot surface. DO NOT touch steam vessel, steam valves, steam hoses and guns in operation.
 - Replace steam hoses immediately if ruptured.
 - Use manufacturer approved spare parts and accessories including steam hoses, steam guns and power cables.
-
- Unplug the product from its power source and allow it to cool before carrying out any maintenance.
 - Never disable sensors in order to bypass an alarm signal.
-
- Open the drain valve and release all remaining water from the steam vessel after users shut down the product completely. (See page 16, "Shutdown Procedures")
 - Never spray steam over cleaning hazardous materials or surfaces containing hazardous substance including asbestos.







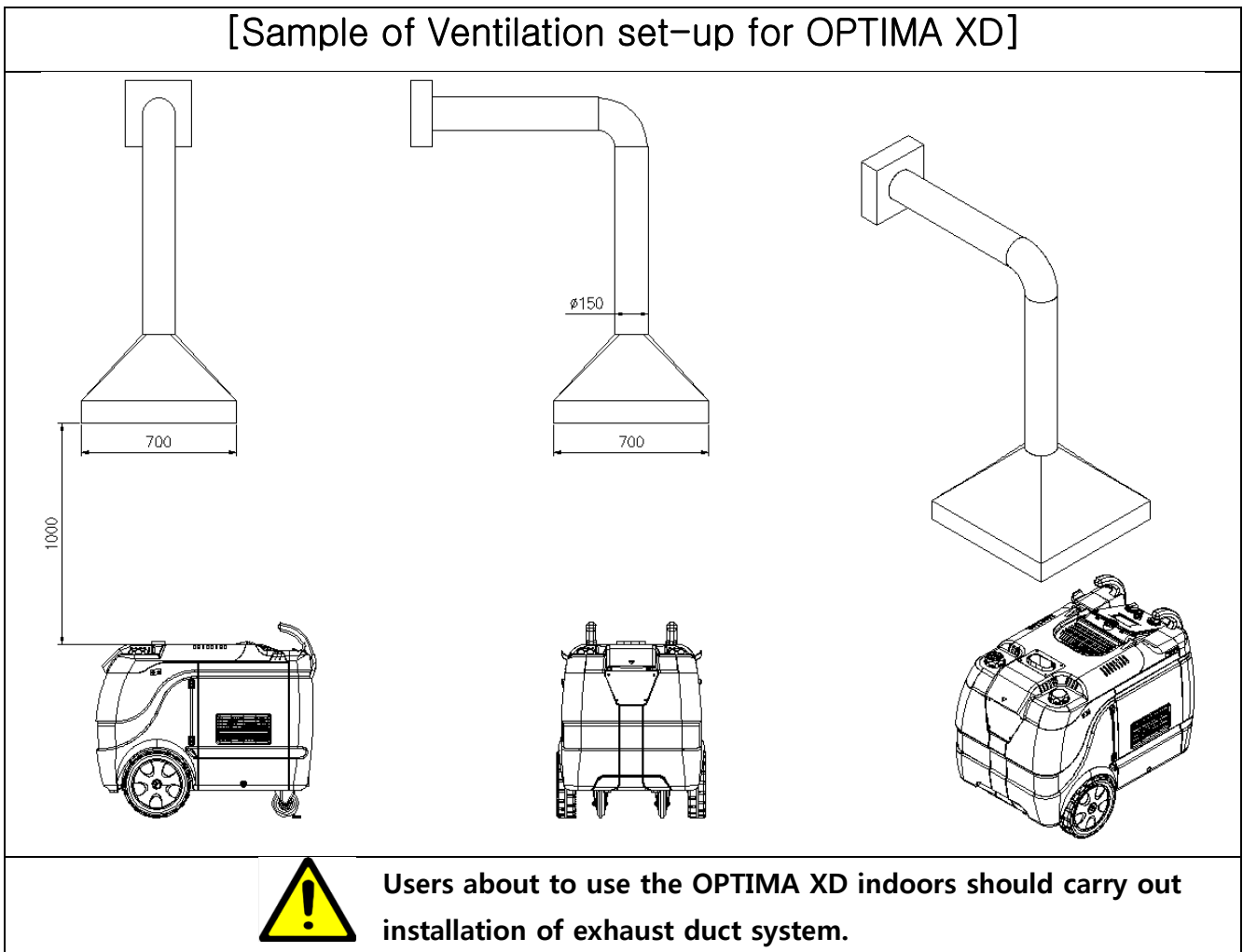







SAFETY RULES for OPTIMA XD

- Use clean diesel only.
- Make sure that all the switches on the product are off before refilling diesel.
- Burn hazard. DO NOT touch exhaust flue in operation.
- DO NOT use the product within a confined space.
- DO NOT breathe in smoke from the exhaust flue to avoid smoke inhalation.
- Use the product in well-ventilated indoor area and install exhaust duct system if necessary. (See page 8, "Ventilation set-up")

[Sample of Ventilation set-up for OPTIMA XD]

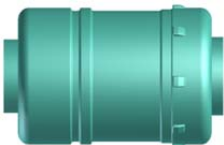



Included Items and Accessories

			
OPTIMA XD		OPTIMA XE	
			
A70015 Steam Gun with nozzle 3.5 – 1ea		A70274 Steam Gun with quick coupler – 1ea	
			
A70026 Steam Nozzle – 1ea A71607 Silence steam nozzle – 1ea		70612 Couplings – 1ea	
			
70007 T wrench 10mm– 1ea 70008 T wrench 12mm – 1ea 15-55002 T wrench 14mm–1ea		70004 Screwdriver(+) - 1ea	
			
70175 Water probe sensor – 3ea		70911 O-ring D.22 – 1ea	
			
71370 Water Filter – 1ea		82-24006 Fuel filter with silicon – 1ea (OPTIMA XD)	
			
71301 towel FBZ – 1ea 71302 towel Warp knitted – 1ea 71303 towel Wool – 1ea		71301 towel FBZ – 1ea 71302 towel Warp knitted – 1ea 71303 towel Wool – 1ea	



* Included items and accessories are subject to change without prior notice.

Pre-Start Procedure

	<p>Wear appropriate protective gear before using the product.</p>
	<p>Surface of exhaust flue and valves may be hot. Take precautions when users resume operations.</p>

Steps:

1. Connect steam hoses and guns to the steam outlet valves. Ensure a tight connection using appropriate tools.
2. Ensure that valves including drain valve, steam outlet valves are fully closed.

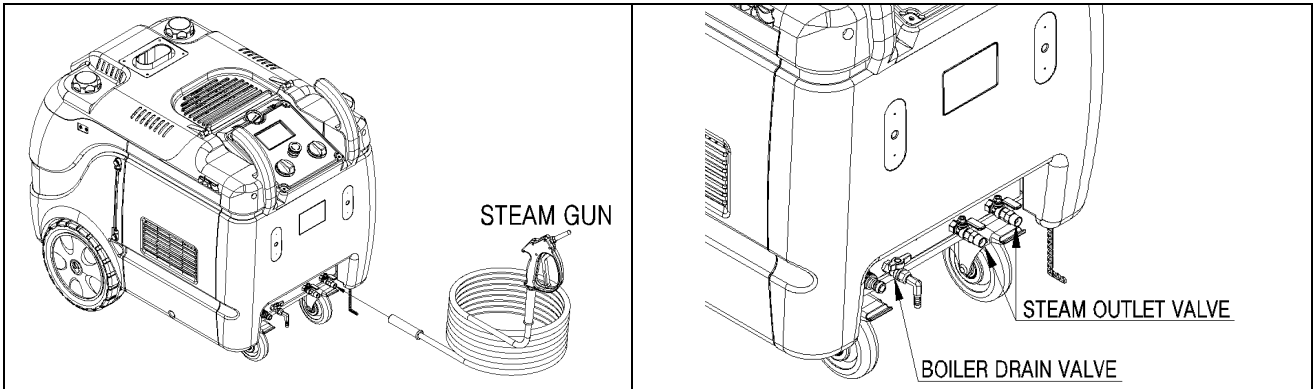

3. Ensure that tank drain plugs or water feeding tube are well-connected.
(See illustrations below)

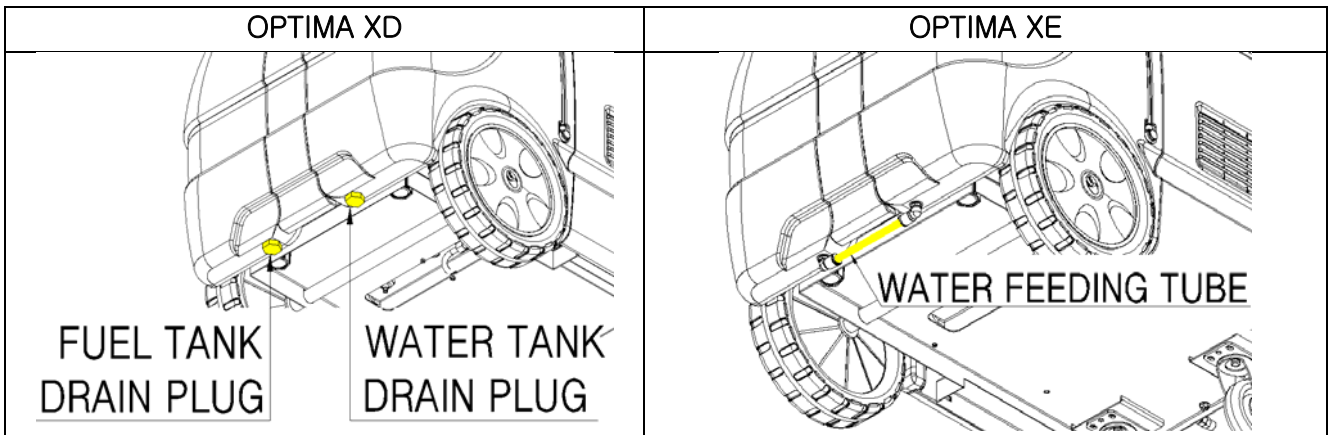

4. Fill the fuel tank. (※For OPTIMA XD)

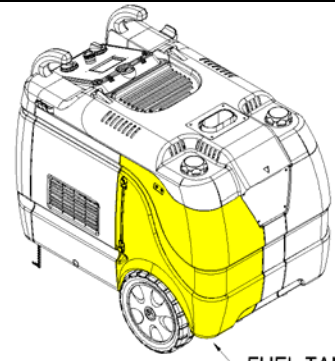

FUEL TANK

Open the black-colored fuel tank cap on the **right side** and fill the tank.



Ensure the location of fuel tank before fuel replenishment.

5. Fill the water tank with clean water. When tap water or hard water is used, use of a water softener is recommended to prevent scale build-up. (See page 31, “Optional Accessories”)

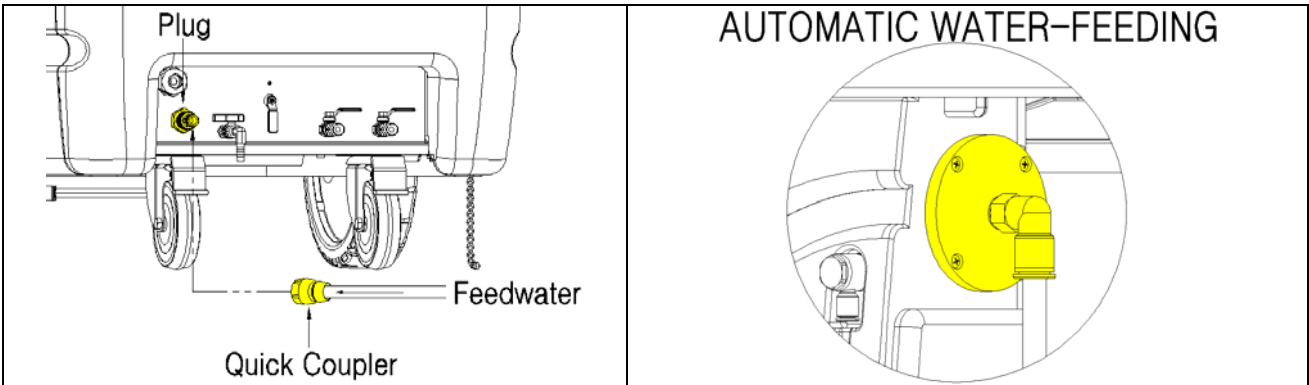

Continuous Water Supply

In the event of using continuous water supply, connect water hose attached with Quick Coupler to the Plug of the product.



Water pressure needs to be below 2bar from the tap for Floater to run effectively.

Water Quality Matters!

Water quality can greatly affect the product's life span and performance. It is important to use SOFT WATER. If tap water or hard water is used, use of a water softener is recommended in order to prevent scale build-up.



- DO NOT use distilled water.*
- DO NOT add any detergent, wax or cleaning additives into the water tank or steam vessel.*
- The use of water temperature above 5°C (40°F) recommended.*
- Use filtered water above 15 ppm.*

6. Check for electrical specifications before connecting to electrical power outlet. In the event of using extension cords, take waterproof measures on the electrical sockets and plugs.

OPTIMA XD	OPTIMA XE	
	<p>Single Phase 5K</p>	<p>3 Phase 12K, 18K, 27K</p>



※ Alert users to the presence of “dangerous voltage” inside the product that might cause bodily harm or electric shock.

For the use of OPTIMA XE, make sure to connect the GROUND WIRE(G) to GROUND TERMINAL. **Never connect GROUND WIRE to NEUTRAL(N) TERMINAL.**

Standard Operating Procedure

Make sure to advance the steps of Pre-Start Procedure before users follow Standard Operating Procedure. (See page 10, "Pre-Start Procedure")

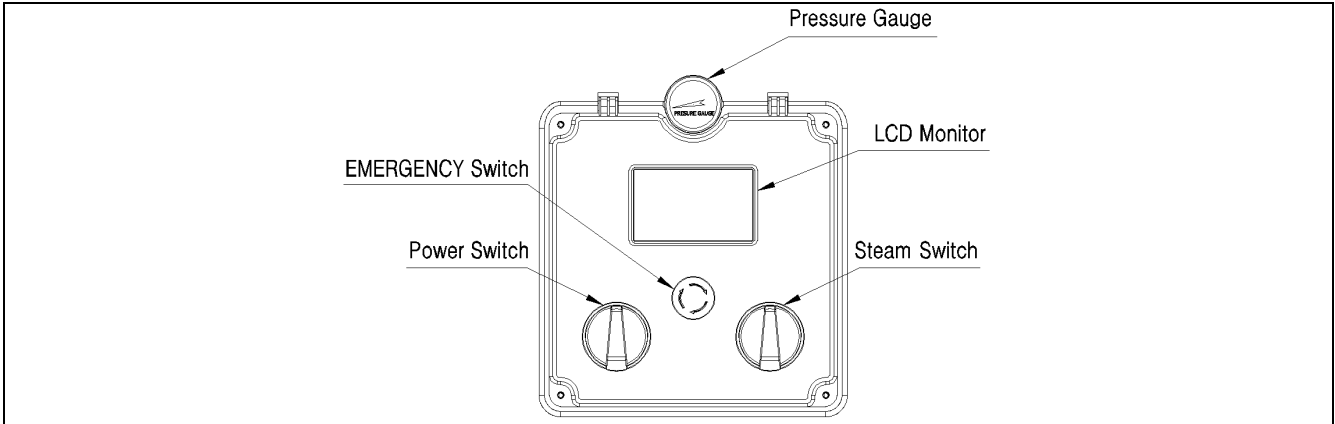



	Wear appropriate protective gear before using the product.
	Never leave the product unattended while operating. Surface of an exhaust flue or valves may be hot. Take precautions while operating.
	DO NOT apply any physical impact to the control panel box or leave any objects on it. DO NOT press LCD Display with your hands or any objects.



LCD ICON DESCRIPTION

	WATER		FUEL
	STEAM VESSEL		WATER PUMP
	HEATING(XD)		HEATING(XE)
	PRESSURE GAUGE		STEAM READY
	TEMPERAURE		AIR PURGE
	BLOWER FAN		CAUTION

OPERATING PROCEDURE

Model	XD	XE
1	<p>Switch on the POWER and Initial boot-up screen is displayed. Switch on STEAM and alarm signal goes off once initiating LCD Display and beginning to run the product according to programming.</p> <p>Note! “OPERATING PROCEDURE” is repeated if users resume the operation after draining all the water out of the steam vessel completely.</p>	

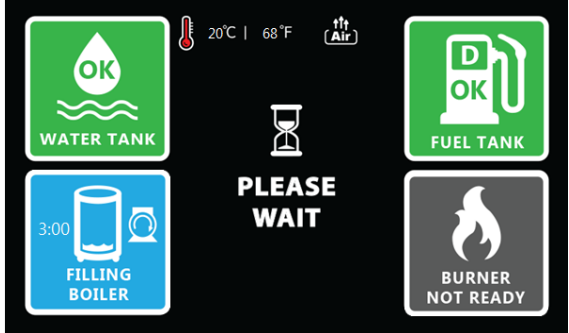
Main Screen		
2		
	Description	
<ul style="list-style-type: none"> ● Switch on the POWER and Initial boot-up screen is displayed with the following information. <ul style="list-style-type: none"> → MAIN BOARD VERSION → DISPLAY BOARD VERSION → OPERATING TIME → OPERATING STATUS MESSAGES 		

Main Screen		
3		
	Description	
<ul style="list-style-type: none"> ● Switch on STEAM. Operating status messages and error signals are displayed. ● Activate water pump to supply water to the steam vessel. ● Programmed water pump running time: <ul style="list-style-type: none"> → OPTIMA XD : 3 min. → OPTIMA XE : 5 min. 		

Model	XD	XE
4	Main Screen	
Description		Description
<ul style="list-style-type: none"> ● When water level reaches the low water probe sensor in the steam vessel, blower fan runs and then combustion occurs. 		<ul style="list-style-type: none"> ● When water level reaches the low water probe sensor in the steam vessel, electric heaters are activated.
5	Main Screen	
Description		Description
<ul style="list-style-type: none"> ● When water level reaches the high water probe sensor in the steam vessel, water pump stops. ● When steam temperature reaches to 80~100°C, air purge valve is closed and "AIR PURGE ON" symbol is disappeared from the LCD Display. 		
6	Main Screen	
Description		Description
<ul style="list-style-type: none"> ● When steam pressure reaches to 8.5 bar, combustion stops and "STEAM READY" message is displayed. ● Blower fan stops running and its symbol is disappeared in 30 seconds from the moment "STEAM READY" symbol is displayed. 		<ul style="list-style-type: none"> ● When steam pressure reaches to 8.5 bar, electric heaters stops operating and "STEAM READY" message is displayed.

Adjust air flow (For OPTIMA XD)

Amount of air intake consumed can be subject to differ depending on ambient environment.

(※ Combustion gas should be visually transparent)

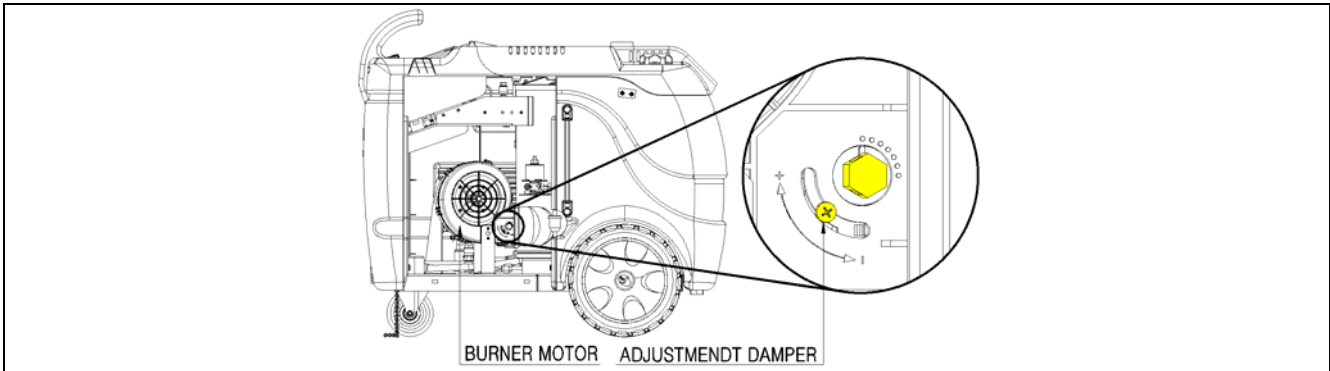

1. Open the plastic cover on the right side.
2. Slightly untighten air adjustment damper using a screw driver(+) and adjust an amount of air intake manually.
3. Retighten the screw of Air Adjustment Damper

Black Smoke from exhaust flue :

Move air adjustment damper clockwise

Whitish Smoke from exhaust flue :

Move air adjustment damper counter-clockwise



DO NOT breathe in combustion gas from the exhaust flue.

Moisture Control

Users can spray moisturized steam (wet steam) by opening the moisture control valve.

In the event of cleaning interior surfaces or water sensitive areas, ensure that the moisture control valve is fully closed to minimize surface moisture.



Using two steam guns with the moisture control valve open continuously may consume steam faster than what can be replenished. Open the moisture control valve by 1/3 allowing pressure to build up.

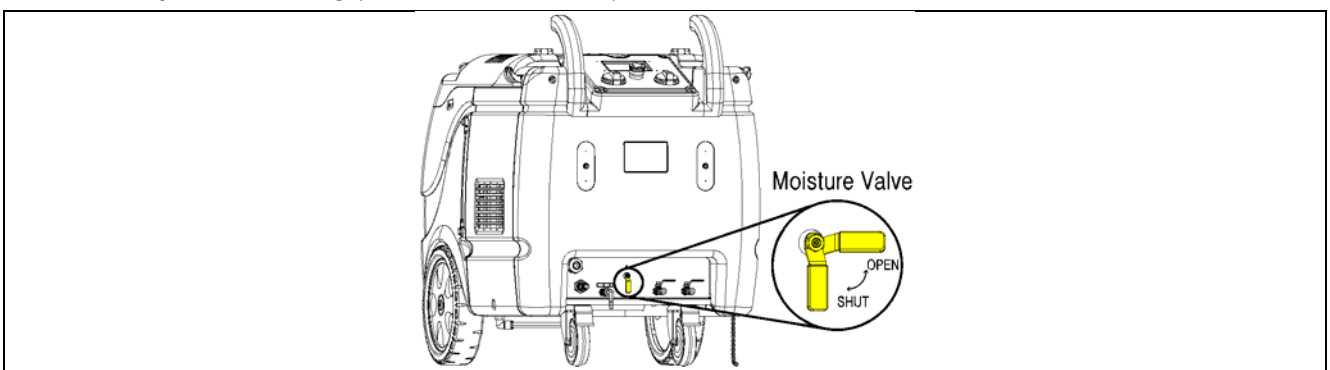

Emergency stop

1. In case of a failure in the product or an emergent situation occurred, push the emergency stop button in.
2. Overhaul the failure, take necessary measures and resume the emergency stop button.

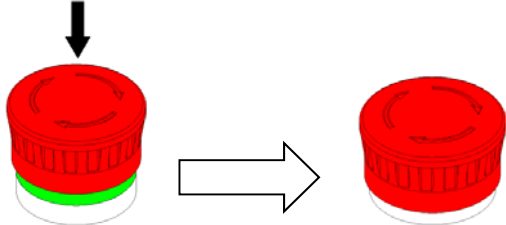
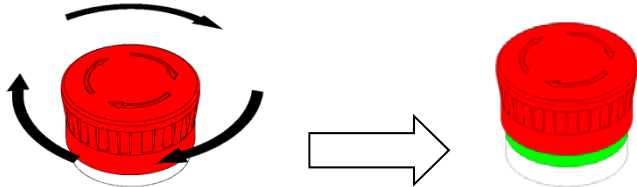
How to use emergency stop button	
Emergency Stop	Resume Operation
	
Push emergency stop button	Release emergency stop button by twisting clockwise



Emergency stop button will shut off all electrical power sequences inside the main power enclosure.

Pause operation

1. Switch off the STEAM.
2. Close the steam outlet valves and release all the remaining steam from the hoses by pulling the gun trigger. It prevents remaining of condensed water residue in the steam hoses afterwards and increases the life span of the steam hoses and guns.

Shutdown operation

1. Switch off the STEAM.
2. After blower fan stops automatically (applied to XD model), switch off the POWER.
3. Release steam from the steam vessel by pulling the gun trigger until the pressure drops down to 1~2 kg/cm²(28.4 psi).
4. Close the steam outlet valves and release all the remaining steam from the hoses by pulling the gun trigger.
5. Release remaining steam from the steam vessel by opening the drain valve.



Keep drain valve open for the next operation









DANGER. Burn hazard! Hot steam. Keep hands clear.

6. In cold weather, take precautionary measures to keep water pipes from freezing and bursting. (See page 21, "Freeze Prevention").

Maintenance

Before to check product

	Must cool down the product.
	Must get rid of pressure in the product.
	Wear appropriate protective gear.
	Unplug to shut down the power.
	Caution of burn
	Keep the below maintenance schedule.

Maintenance Schedule

	Maintenance items	Daily	Monthly	Every 3months	Every 6months
A	Drain boiler	✓			
B	Drain Water / Fuel tank		✓		
C	Replace filters		✓		
D	Check probes / clean or replace if necessary		✓		
E	Check electrodes and fuel nozzle and clean it (Contact dealer)			✓	
F	Descale boiler inside (Contact dealer)				✓
G	Clean Cylinder inside / remove soot (Contact dealer)				✓

A. Drain boiler

1. Reduce pressure below 2 kg/cm²(28.4 psi)
2. Open the drain valve until water drained out.
3. Leave drain valve open until the next use.



Wear appropriate protective gear for eyes and hands because steam is very hot.



Leave drain valve open until the next use.

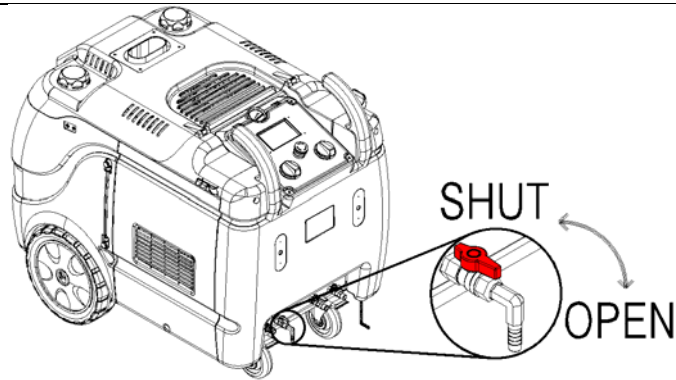

B. Drain Water / Fuel tank

Open drain plug under the tank or disconnect the tank connection hose.



Caution : Slippery when wet

<p>OPTIMA XD</p>	<p>Open drain plug under the tank.</p>	<p>FUEL TANK DRAIN PLUG</p> <p>WATER TANK DRAIN PLUG</p>
<p>OPTIMA XE</p>	<p>WATER FEEDING TUBE</p> <p>Push the fitting and pull out the hose.</p>	<p>1. PUSH</p> <p>2. PULL</p>

C. Replace filters

Check water filter regularly and replace if necessary.

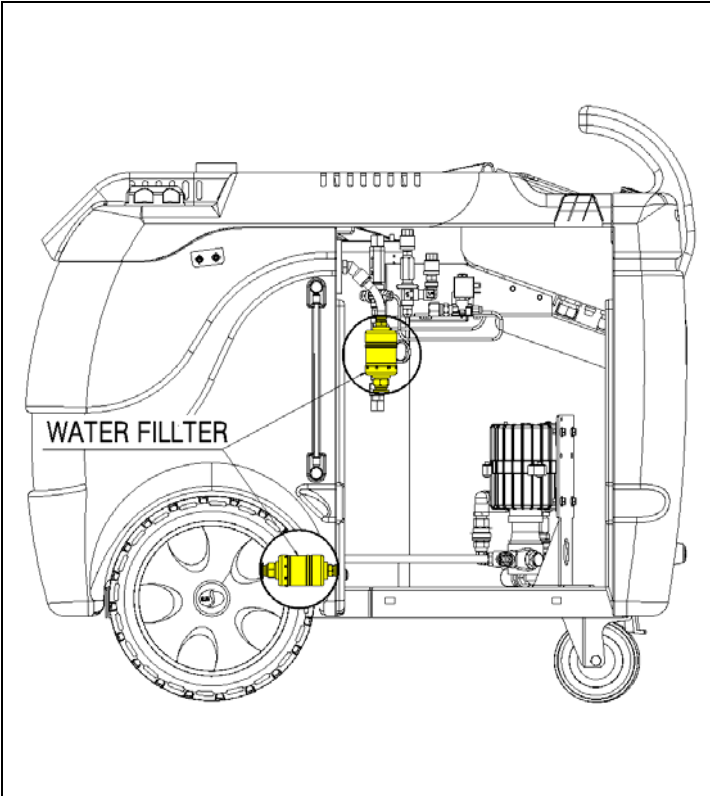
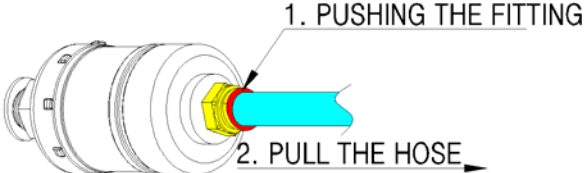
	How to replace water filter
	<ol style="list-style-type: none">1. Drain out all water from water tank. (Refer P. 18)2. Push the fitting(red part) and pull the hose(blue part). 3. Replace New filter. <p>Check the direction of filter when you replace it. (Refer the drawing left)</p> <ol style="list-style-type: none">4. Insert hose to filter and push it until it connects completely. (you can not pull out the hose by hand)

There is fuel filter for **OPTIMA XD**. Please check it regularly and replace it if necessary.

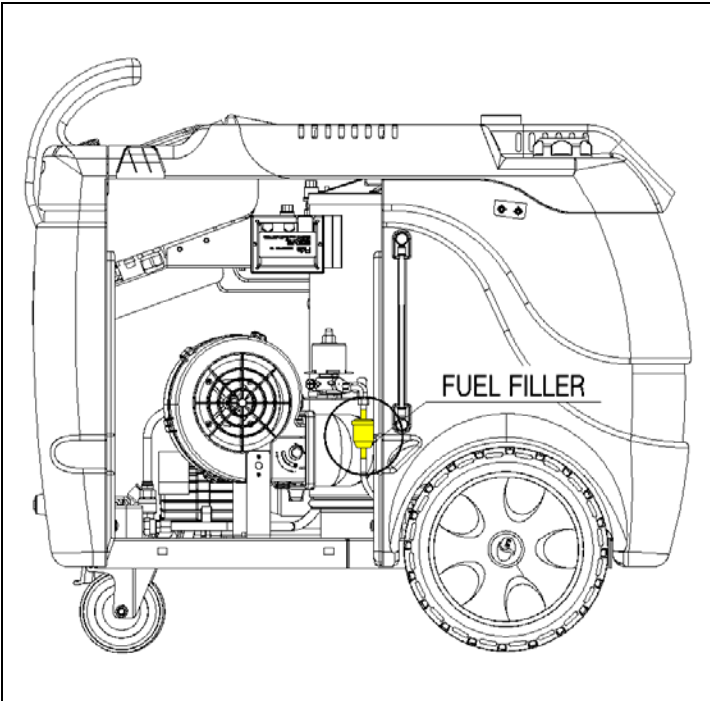
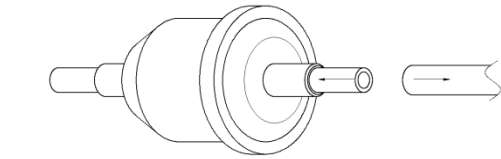
	How to replace fuel filter
	<ol style="list-style-type: none">1. Drain out all fuel from fuel tank by opening drain plug under the tank. (Refer P. 18)2. Disconnect the fuel hose from fuel filter by pulling. 3. Replace new fuel filter. <p>Check the direction of filter.</p> <ol style="list-style-type: none">4. Connect them again by pushing the fuel filter outlet into the fuel hose.

D. How to check and clean water probes

There are 3 water probes (high/common/low).

Minerals in the water or various foreign materials would be hardened and this may make water probe's malfunction.

Requires : Screwdriver(+), 14mm long box wrench or Spanner, Sand paper, Teflon tape.

Procedure:

1. Unplug the power plug and then remove pressure completely by opening steam valve.
2. Open the drain valve and drain out all water from boiler.
3. Detach top cover and front cover. Then detach the all wires from water probe sensors.
4. Disconnect water probe sensors from steam vessel by 14mm long box wrench.
5. Clean the water probe sensor by soft sand paper. Replace it if necessary.
6. Wind Teflon tape 6 times on the thread in order to prevent leakage.

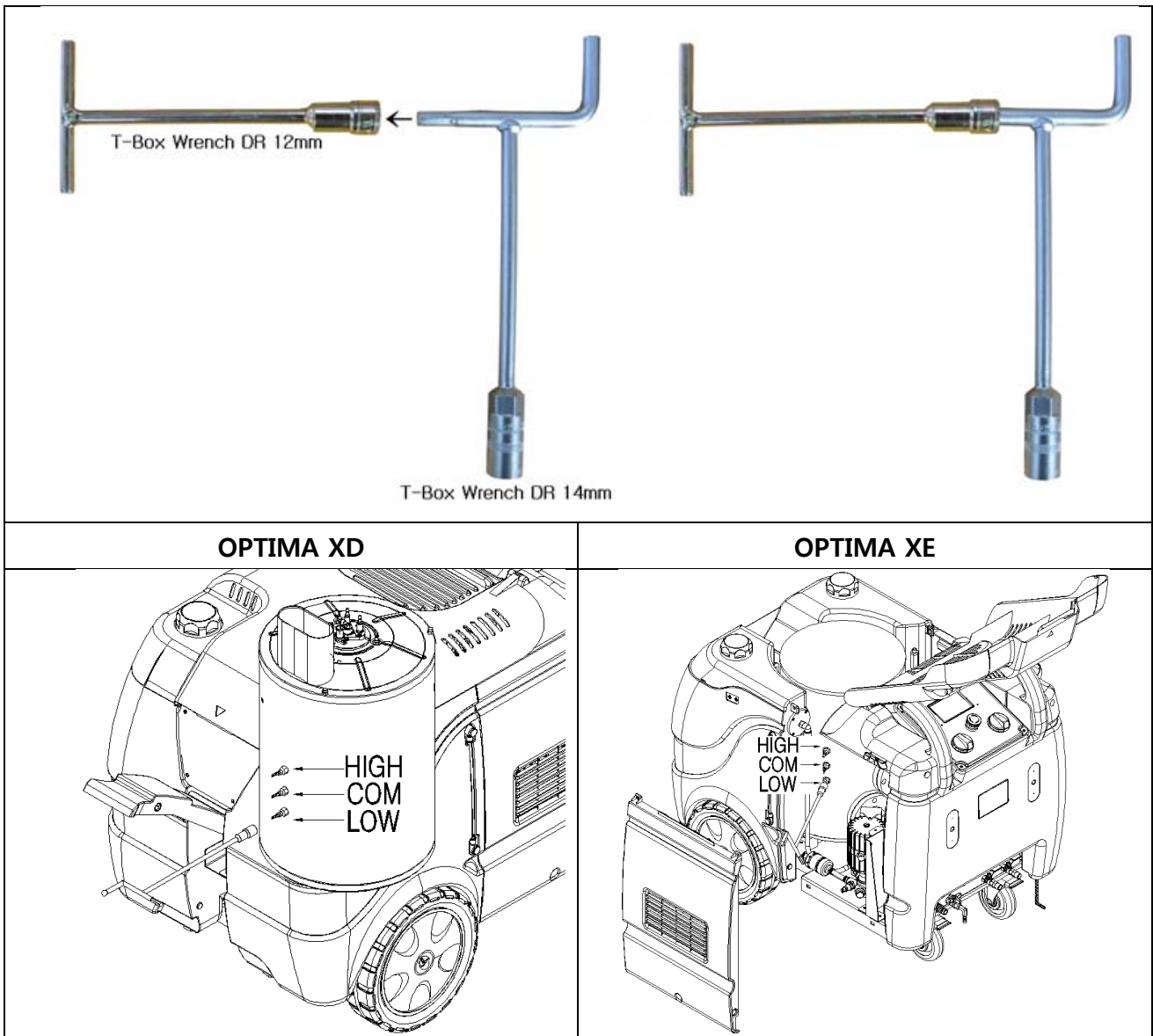

Freeze Prevention



In cold climates, it is necessary to store the product in an area where a temperature is above freezing. Follow the below steps to protect your product against freezing and bursting.

Steps:

1. Drain the steam vessel

Reduce pressure under 2 kg/cm²(28.4 psi) and then drain out water from the steam vessel by opening a drain valve. Leave the drain valve open until the next use.



Steam is extremely hot, we are appropriate hand and eye protection.



Leave drain valve open until next use.

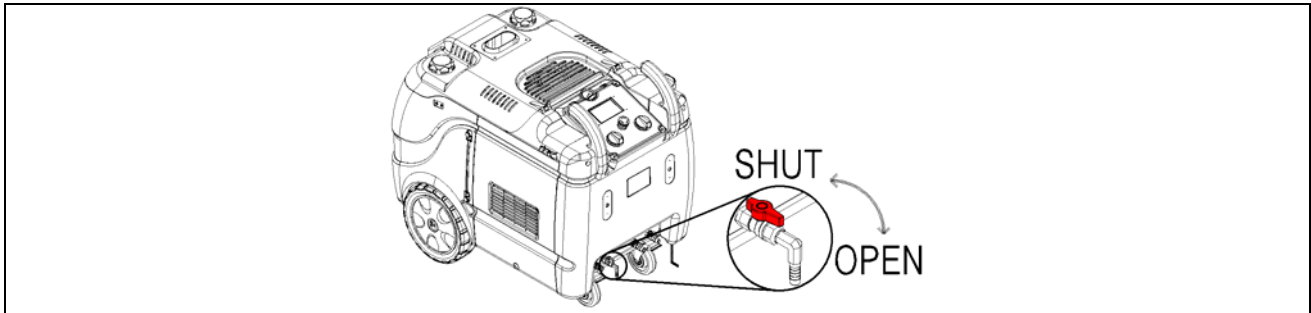

2. Drain Water tank

Open a drain plug or water tank connection tube under the water tank.

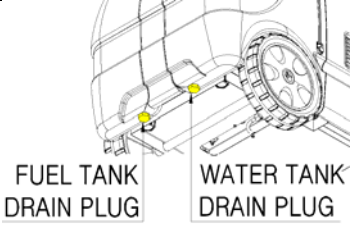
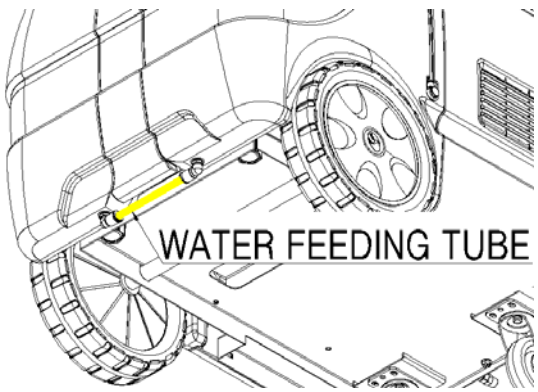
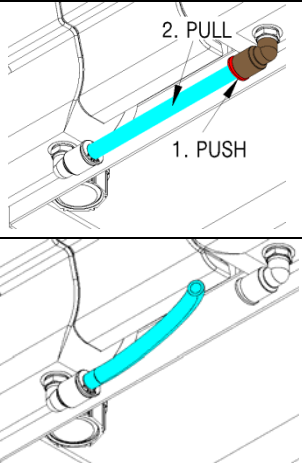

Caution : Slippery when wet.

OPTIMA XD	<p>Open drain plug under the tank.</p>  <p>FUEL TANK DRAIN PLUG WATER TANK DRAIN PLUG</p>
OPTIMA XE	 <p>WATER FEEDING TUBE</p> <p>Push the fitting and pull out the hose.</p>  <p>2. PULL 1. PUSH</p>

3. Drain the water feeding lines and the water pump.

Open the drain valve, then disassemble/detach water feeding line like the below picture and drain all remaining water using compressed air. Keep drain valve open until next use.

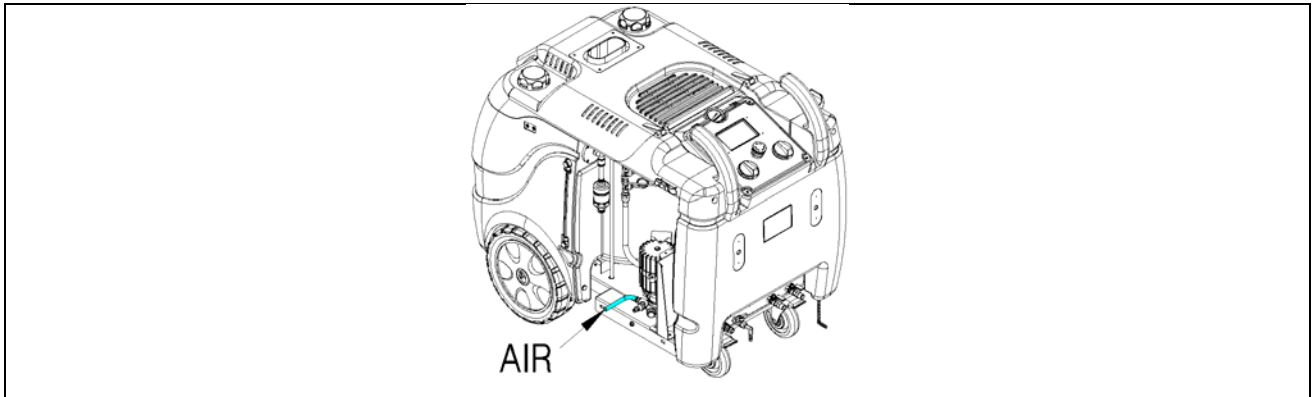

4. Storage

Keep Product in a warm place to prevent for being frozen.





Pipe line or parts can be ruptured, if product is frozen badly. Freeze can cause malfunction. If product would be frozen, do not operate it immediately. Put the product in warm place in order to thaw. After that, check if there is any damage.

If the machine is visually damaged or performs abnormally, immediately turn off the machine and contact your distributor or manufacturer.

Troubleshooting Guide



When a malfunction occurs, refer to the troubleshooting guide below. If the problem persists, please contact your local distributor and report the problem by referring to the ERROR CODE.

Symbol Description

	Alarm beeps continuously		Alarm beeps once		Continuous pressure increases over 9 bar (130 psi)
---	--------------------------	---	------------------	---	--

Error display and Solution

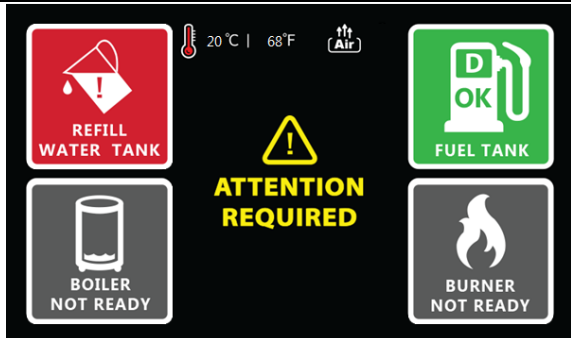
1	Description	Nothing on LCD screen and no alarm sound when POWER & STEAM switches are on.	
	Cause & Remedy	1) No power supply.	→ Check your electrical power source. → Check power plug connection.
		2) Emergency Stop switch is pressed.	→ Release the Emergency Stop switch.
		3) Fuse is blown.	→ Replace the fuse.

2	ATTENTION REQUIRED		ATTENTION REQUIRED	
				
	Description	 REFILL WATER TANK icon is flashing in red color and buzzer is beeping. ◆ Not enough water in the water tank.		
Cause & Remedy	1) Water shortage.		→ Refill water to the water tank.	
	2) Malfunction of the float switch in the water tank.		→ Disconnect one wire from the float switch of water tank and if the error disappears, replace the float switch and connect wires in position.	

	OPTIMA XD	OPTIMA XE
	ATTENTION REQUIRED	DOES NOT APPLY
3		
Description	REFILL FUEL TANK icon is flashing in red color and buzzer is beeping. ◆ Not enough fuel in the fuel tank.	
Cause & Remedy	1) Fuel shortage. → Refill fuel to the fuel tank. ----- 2) Malfunction of the float switch in the water tank. → Disconnect one wire from the float switch of fuel tank and if the error disappears, replace the float switch and connect wires in position.	





	ERROR CODE : DW01	ERROR CODE : EW01
4		
Description	BOILER LEVEL ERROR icon is flashing in red color and buzzer is beeping. ◆ Water level of the boiler may not enough.	
Cause & Remedy	1) Dirty water filter. → Check or replace the water filter. ----- 2) Malfunction of the water pump. → Check or replace the water pump. ----- 3) Malfunction of the water probe sensors. → Clean or Replace the all water probe sensors of the boiler.	

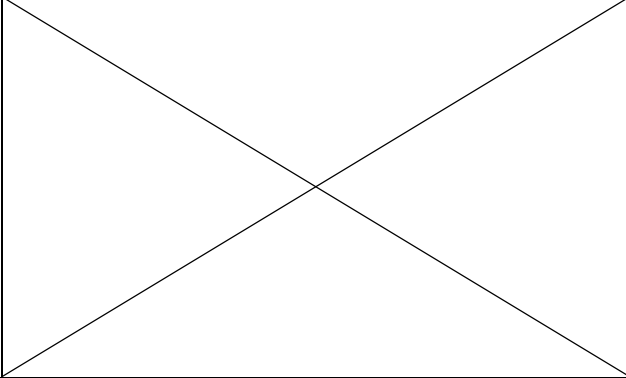

	OPTIMA XD	OPTIMA XE
5	ERROR CODE : DW02	ERROR CODE : EW02
	Description	BOILER LEVEL ERROR icon is flashing in red color and buzzer is beeping. ◆ Malfunction of the water probe sensors.
Cause & Remedy	1) Malfunction of the water probe sensors. → Clean or Replace the all water probe sensors of the boiler.	
6	ERROR CODE : DW03	ERROR CODE : EW03
	Description	BOILER LEVEL ERROR icon is flashing in red color and buzzer is beeping. ◆ Pressure increase by water oversupply.
Cause & Remedy	1) Malfunction of the water probe sensors. → Clean or Replace the all water probe sensors of the boiler.	

	OPTIMA XD	OPTIMA XE
	ERROR CODE : DS11	ERROR CODE : ES11
7	<p>BOILER LEVEL ERROR icon is flashing in red color and buzzer is beeping.</p> <p>◆ Malfunction of the pressure switch.</p>	
Description		
Cause & Remedy	<p>1) Malfunction of the pressure switch. → Defrost the machine and try again. → Replace the 8.5 bar pressure switch.</p> <hr/> <p>2) Malfunction of the water probe sensors. → Clean or Replace the all water probe sensors of the boiler.</p>	
	ERROR CODE : DP21	ERROR CODE : EP21
8	<p>BOILER LEVEL ERROR icon is flashing in red color and buzzer is beeping.</p> <p>◆ The water pump runs overtime at initial operation. (XD : 3 min, XE : 5 min)</p>	
Description		
Cause & Remedy	<p>1) Water filter blockage. → Check or Replace the water filter.</p> <hr/> <p>2) Malfunction of the water pump. → Check or replace the water pump.</p> <hr/> <p>3) Malfunction of the water probe sensors. → Clean or Replace the all water probe sensors of the boiler.</p>	

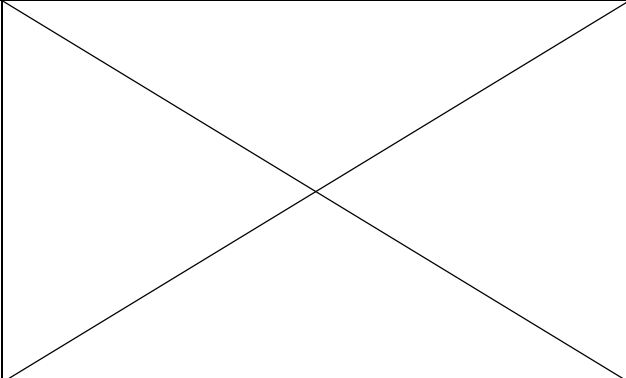
	OPTIMA XD	OPTIMA XE
	ERROR CODE : DP22	ERROR CODE : EP22
9	WATER PUMP OVERRUN icon is flashing in red color and buzzer is beeping. ◆ The water pump runs overtime during normal operation. (60 secs)	
Description		
Cause & Remedy	1) Water filter blockage. → Check or Replace the water filter. ----- 2) Malfunction of the water pump. → Check or replace the water pump. ----- 3) Malfunction of the water probe sensors. → Clean or Replace the all water probe sensors of the boiler.	
	ERROR CODE : DT31	ERROR CODE : ET31
Description	THERMISTOR ERROR icon is flashing in red color and buzzer is beeping. ◆ Thermistor detects low temperature. (Under 0°C/32°F)	
Cause & Remedy	1) Low temperature detection by freeze. → Defrost the machine and try again. ----- 2) Malfunction of the thermistor. → Replace the thermistor.	

	OPTIMA XD	OPTIMA XE
11	ERROR CODE : DT32	ERROR CODE : ET32
	Description	Display ERROR CODE("DT32" or "ET32"). ◆ Thermistor has been shorted.
Cause & Remedy	1) Malfunction of the thermistor. → Replace the thermistor.	
12	ERROR CODE : DT33	ERROR CODE : ET33
	Description	THERMISTOR ERROR icon is flashing in red color and buzzer is beeping. ◆ Thermistor detects high temperature. (Over 200°C/392°F)
Cause & Remedy	1) Malfunction of the pressure switch. → Replace the 8.5 bar pressure switch. <hr style="border-top: 1px dashed black;"/> 2) Malfunction of the thermistor. → Replace the thermistor.	

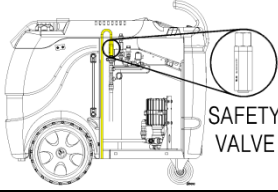
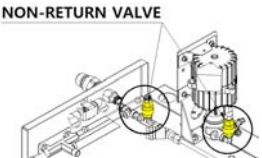
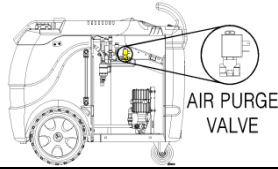
		OPTIMA XD	OPTIMA XE
		ERROR CODE : DF41	DOES NOT APPLY
			
13	Description	 FLAME DETECTING ERROR icon is flashing in red color and buzzer is beeping. ◆ Flame detection fault.	
Cause & Remedy		1) Incomplete combustion → Check and Clean components of combustion chamber and check blower fan. 2) Malfunction of the fuel filter or fuel pump. → Check or Replace the fuel filter or fuel pump. 3) Malfunction of the flame detector. → Replace the flame detector. 4) Malfunction of the pressure switch. → Replace the 8.5 bar pressure switch.	
		ERROR CODE : DF42	DOES NOT APPLY
			
14	Description	 FLAME DETECTING ERROR icon is flashing in red color and buzzer is beeping. ◆ Abnormal detection of flame detector.	
Cause & Remedy		1) The flame sensor has been exposed by light from outside. → Check a rubber packing on the flame detector. 2) Malfunction of the flame detector. → Replace the flame detector.	

15	Description	Boiler pressure keeps increasing above 9 bar (130 psi). 
	Cause & Remedy	1) Malfunction of the pressure switch. → Replace the pressure switches.
		2) Malfunction of the water probe sensors. → Clean or Replace the all water probe sensors of the boiler.
3) Using distilled water → Use normal tap water. (above 15 ppm)		
16	Description	Steam or water leaks from underneath.
	Cause & Remedy	1) Safety valve has activated. → Solve the reason of abnormal pressure and replace the safety valve.
		2) Damaged by freeze rupture. → Replace a broken part.
3) Damaged piping line. → Fix or replace a broken part.		
		
17	Description	Water supplying tube of water pump is hot or damaged.
	Cause & Remedy	1) Malfunction of the non-return valve. → Replace the non-return valves and damaged parts.
		
NON-RETURN VALVE		
18	Description	Water tank is abnormally hot.
	Cause & Remedy	1) Malfunction of the air purge valve. → Clean or Replace the air purge valve.
		2) Malfunction of the thermistor. → Replace the thermistor.
		
AIR PURGE VALVE		
19	Description	Static electricity on the spray gun or the machine..
	Cause & Remedy	1) The machine is not grounded properly. → Ensure that the machine is grounded using the grounding chain located at the rear bottom of the machine.
		
Grounding Chain		

OPTIONAL ITEMS

OPTIMA DM(DMF) is designed to use with various useful optional items as below.

1. ACCESSORIES

		
<p>Turbo Steam Nozzle with Quick Plug</p>	<p>Hand Tool</p>	<p>Floor Spinner with lance</p>
		
<p>Silence Steam Nozzle with Quick Plug</p>	<p>SQUEEGEE WAND</p>	<p>MOP WAND</p>

2. OMEGA SOFTENER (Portable Water Softener)

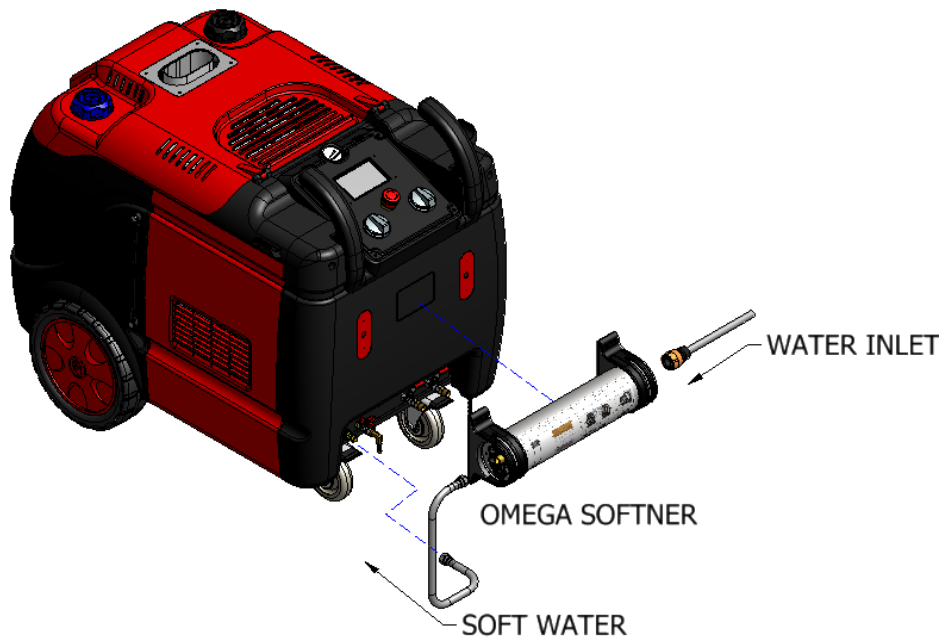

※ Please visit our website to see more details. (<http://www.sjecorp.com>)



Some items can be changed or discontinued without notice.

Technical Service Request Form

Thank you for using our products.

When you encounter any problems using the Optima Steamer, please fill out the form and contact your seller. We will be in contact with you until the issue is resolved to your satisfaction.

No	Description	Remark
Items that should be checked		
1	What is the serial number of the machine?	
2	Tell us the version of your machine that shows in LCD display.	
3	Did you physically check water tank to see if it is filled?	
4	XD) Did you physically check fuel tank to see if it is filled?	
5	How many hours per day average do you operate your machine?	
Continue to items below after the POWER (EMERGENCY STOP) and STEAM switches are on		
6	Does LCD display turn on after STEAM switch is on?	
7	Does the alarm beep continuously after STEAM switch is on?	
8	Tell us an error code that display shows.	
9	Is there a sudden increase of the pressure gauge over 9 bar (130 psi)?	
10	Has any cold water exited from steam outlet valve when the valve is opened?	
11	Do you hear any weird sound for the machine?	
12	Can you feel any static electricity from the machine or steam gun?	
13	XD) Please distinguish the color of smoke if it occurs. Black – Dark Gray – Gray – White – Blue – Green or None (clear)	
14	XD) Is there blowing air from the flue during operation?	
15	XD) Is there a continuous crashing sound between Scroll and Impeller of the blower fan?	
16	XD) Is the combustion chamber is still igniting even though STEAM switch is off?	
17	Other symptoms:	
Company		Name
E-mail		Phone

SJE Corporation Ltd.

OPTIMA STEAMER SERIES LIMITED WARRANTY

SJE Corporation Ltd. hereby warrants that new Optima Steamers purchased directly from SJE Corporation Ltd., headquartered in Busan, South Korea will be free from defects in material and workmanship for the period of time stated below, subject to certain limitations.

OUR WARRANTY POLICY

This warranty is not transferable and covers replacement parts only. This warranty does not cover any consequential damages or business loss.

THE PERIOD OF WARRANTY

The warranty on your Optima Steamer is twelve(12) months(6months for authorized distributors) from the date of purchase by the original owner against defects in material and workmanship.

GENERAL EXCLUSIONS

General exclusions from this warranty shall include any failures caused by:

- a. Installation of parts, attachments or accessories that are not original to the unit or genuine Optima Steamer parts.
(i.e. external aftermarket attachments such as exhaust duct extension)
- b. Abnormal strain, neglect, or abuse.
- c. Lack of proper maintenance.
- d. Accident or collision damage.
- e. Changing or altering factory settings without consulting with an authorized technician.
- f. Damage or malfunctions resulting from natural calamity, freezing, theft, accident, vandalism, abuse due to misapplication and/or improper site conditions.
- g. Water damage
- h. Electrical damage from including, but not limited to improper use of extension cords, failure to meet proper voltage requirements, incorrect or insufficient amperage circuit.
- i. Insufficient unobstructed distance on exhaust

Items not covered under warranty include:

- a. Parts replaced due to normal wear or routine maintenance including, but not limited to sensors, filters, fuses, valves, pipes, electrodes, cables and fittings (i.e. nipples, couplings, o-rings, etc)
- b. Consumable or wearing items requiring replacement as part of normal operation including, but not limited to steam hoses and guns.
- c. Any transportation or travel costs.
- d. Reimbursement for rental units while repairing warranty items.
- e. Normal maintenance items such as: draining tanks and boiler, descaling, filter and sensor changes, boiler cleaning, tightening and sealing bolts and fittings and others stated in the User Manual.
- f. Failure caused by water scale problem due to local water conditions.
- g. Warranty work completed after 30 days from discovery.
- h. Damage, problems or failure caused by factors external to the Product including, but not limited to, faulty or poor external electrical wiring, incorrect or faulty power supply, voltage fluctuations, over voltage transients or electromagnetic interference, inadequate or faulty water or fuel.

CUSTOMER'S RESPONSIBILITY

Under this warranty, the customer's responsibility shall be to:

- a. Operate and maintain the machine as specified in the instructions manual.
- b. Give notice to authorized Optima Steamer dealer or SJE Corporation Ltd. of apparent defects within seven (7) days after discovery.
- c. Provide proof of purchase, purchase date, and serial number of the warranty item(s).
- d. Make the unit available for inspection and repairs at dealer's place or service center. If shipped, transit costs should be prepaid.

For warranty service request, please e-mail tech@sjecorp.com or call +82 51 521 3200.

SJE Corporation Ltd. recommends that you read the Operating Instructions, and in particular the troubleshooting guide on USER'S MANUAL before you make a Warranty service call.



SJE Corporation, Ltd.
Global Leader of Green Solutions

[Hand office]

78-21, Sandan-7ro, Jeonggwan-Myeon,
Gijang-Gun Busan, South Korea

[Customer Center]

C203, 40, Imi-ro, Uiwang-si Gyeonggi-do,
South Korea

T: +82 51 521 3200

F: +82 51 521 3305

sales@sjecorp.com

www.sjecorp.com

[US Office - Steamerics, Inc.]

California, USA

T: +1 844 US STEAM

www.steamerics.com

www.sjecorp.com

